

REV	DATE	MODIFICATION	修改内容	修改人
2012/09/19				
2017/05/04			客户需求产品变更, 刻字零件增大	Shan

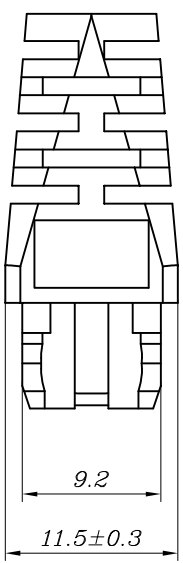

规格	印字	无印字
TYP1	ø6.0	
TYP2	ø6.5	

客户用产品图

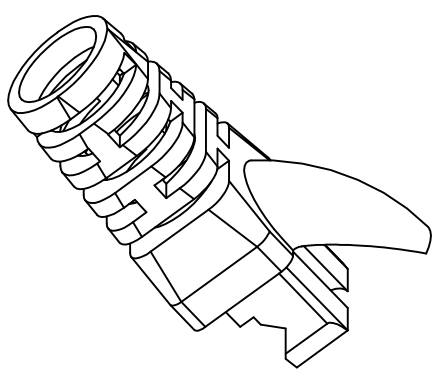
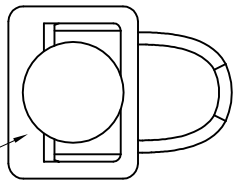
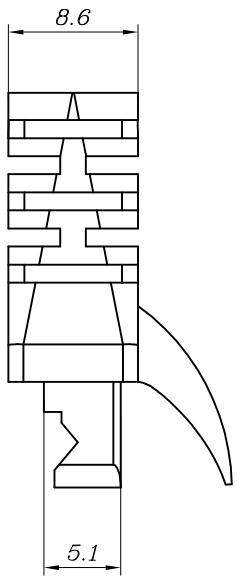
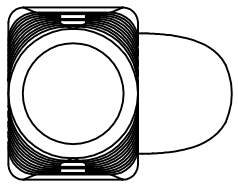
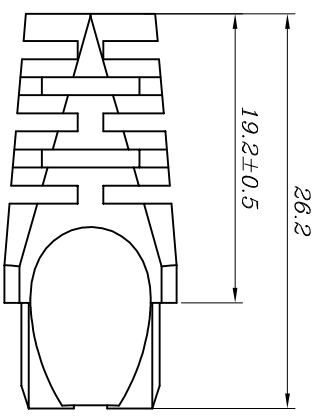

<b>EXW</b> 宁波卓新通讯连接器有限公司 NINGBO EXCELLENCE COMMUNICATED CONNECTOR CO.,LTD		材 质 MATERIAL	图 号 DWG NO.
DIMENSION IN mm (Inch) TOLERANCE UNLESS OTHERWISE SPECIFIED		PVC	ASSEMBLY.SR-128
.X±0.20	.X°±5°	名称 TITLE	02-128 一体式护套(C6)
.XX±0.10	.XX°±2°	制 图 DRAWN	比 例 SCALE
审 核 APPROVAL	核 对 CHECKED	LiJing	2/1
沈红波	钟均江	角 法 PROJ.	张 数 SHEET
			1/1
			更 改 REV
			C

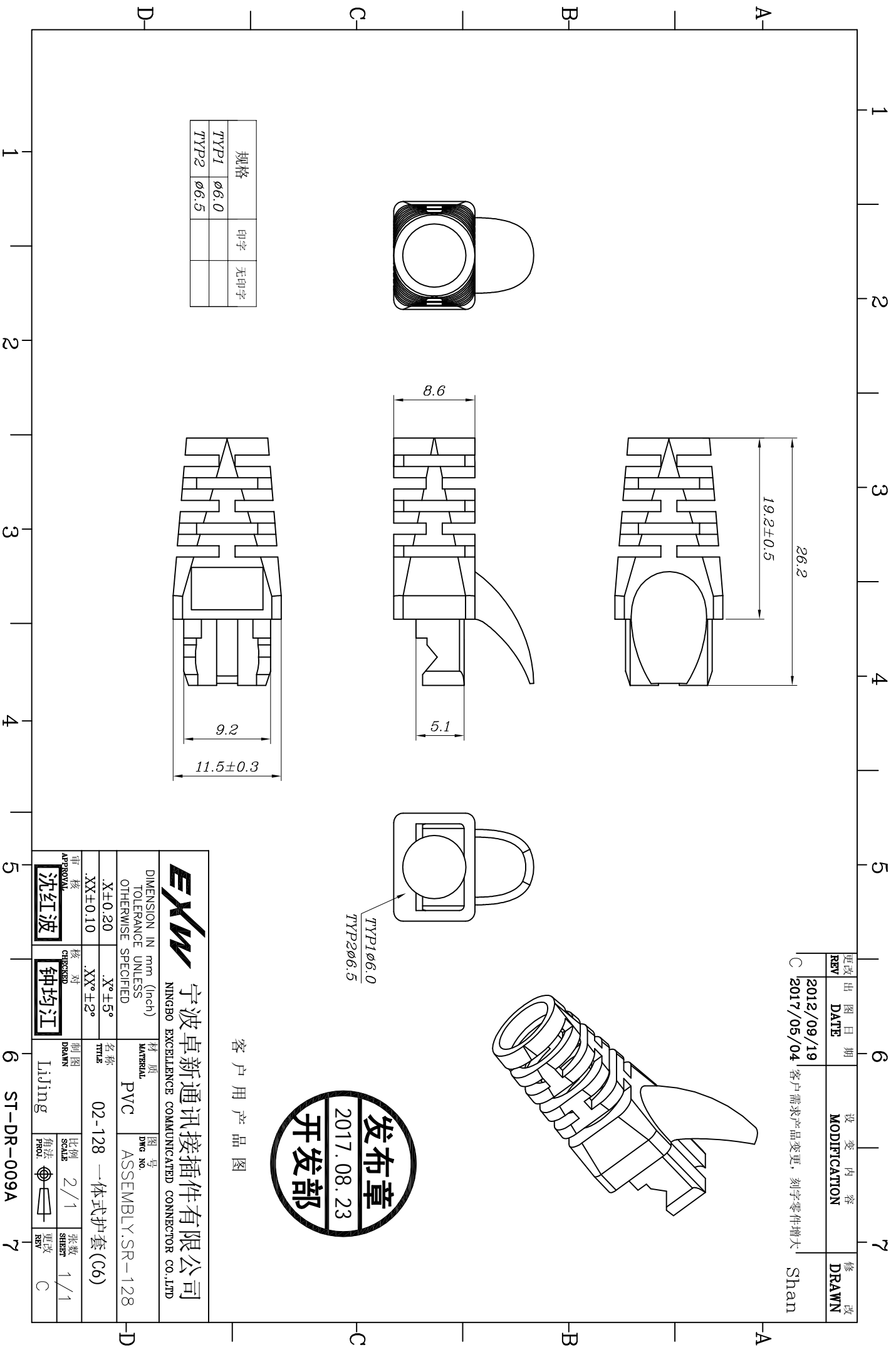

ST-DR-009A